

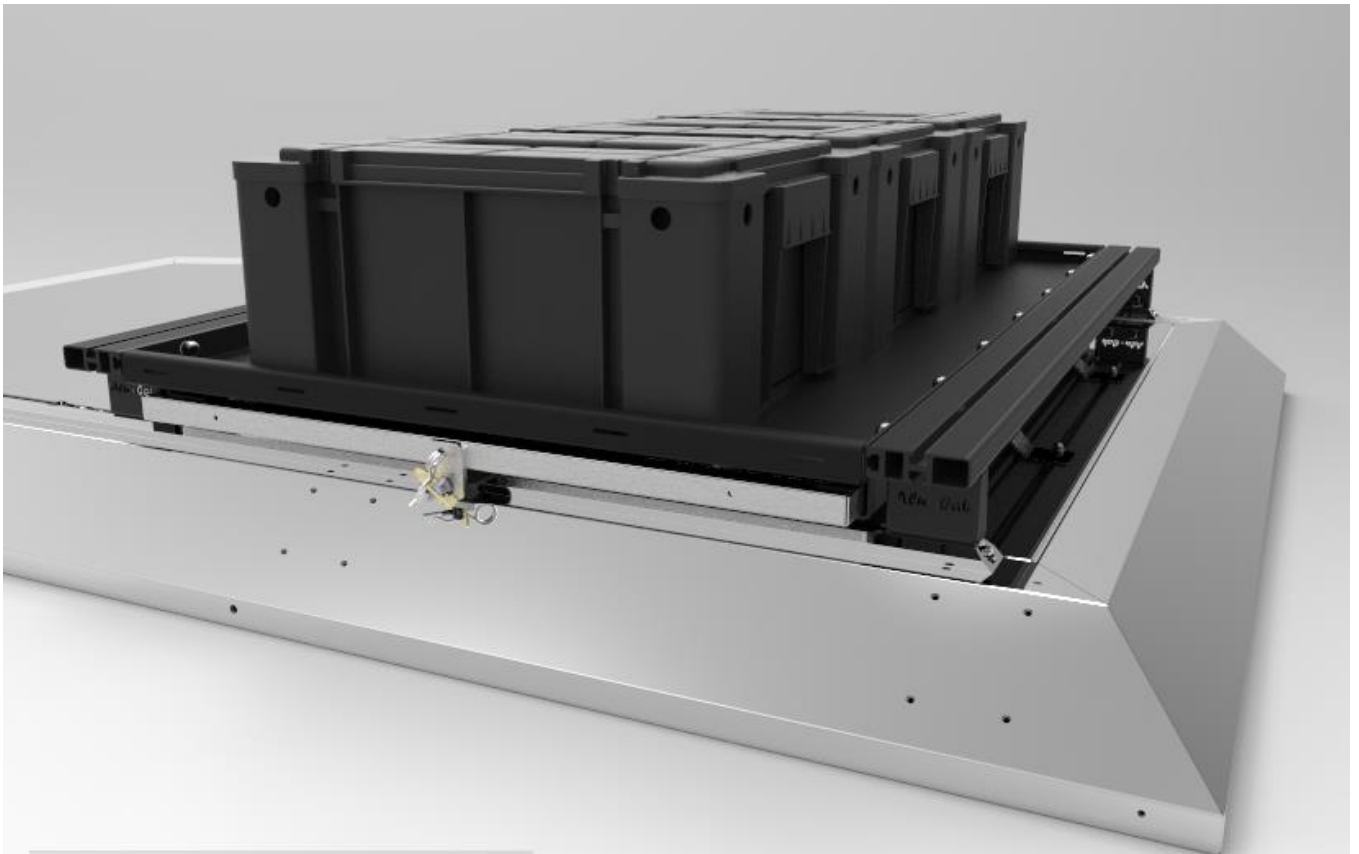

# Roof Rack Tray & Load Bar Table Slide

## Fitment Instructions



**The following fitment instruction will show you how to fit the Roof Rack Tray and the Load Bar Table Slide. Should you only need to fit the Load Bar Table Slide, skip step 4**

**Roof Rack Tray & Load Bar Table Slide – Fasteners & Materials**

The tables below show the equipment, i.e. tools, fasteners, hardware and consumables required to start and finish the fitment of the Roof Rack Tray kit & Load Bar Table Bracket kit:

**Hardware supplied with Roof Rack Tray Kit:**

<b>ITEM NO.</b>	<b>PART NUMBER</b>	<b>DESCRIPTION</b>	<b>QTY.</b>
1	413-ROOF-TRAY-01-00	Roof Tray	1
2	M8 Plastic Nut Caps	M8 Plastic Nut Caps	14
3	M8x20 HEX BOLT	M8x20 HEX BOLT	14
4	M8 NYLOC NUT	M8 NYLOC NUT	14
5	M8 FLAT WASHER	M8 FLAT WASHER	14

**Hardware Supplied with Load Bar Table Bracket kit:**

<b>ITEM NO</b>	<b>PART NUMBER</b>	<b>DESCRIPTION</b>	<b>QTY.</b>
1	Load Bar Table Bracket	Load Bar Table Bracket	2
2	Roof Rack Feet	Roof Rack Feet	4
3	M8x20 HEX BOLT	M8x20 HEX BOLT	6
4	M8 FLAT WASHER	M8 FLAT WASHER	7
5	M8 NYLOC NUT	M8 NYLOC NUT	7
6	M8 Nut Cap	M8 Nut Cap	7
7	420-MNT-BRKT-01-00	Lock Mount Bracket	1
8	M8 ANTILUCE BODY	M8 ANTILUCE	1
9	R-Clip	R-Clip	1
10	SPRING WASHER - M8	SPRING WASHER - M8	1
11	Cargo Rail Nut	CARGO RAIL NUT	2
12	M8x10 CSK Screw	M8x10 CSK Screw	2

### **Hardware supplied with Load Bars:**

1	1250mm Load Bars	1250mm Load Bars	2
2	Plastic Load Bar End Caps	Plastic End Caps for Load Bars	4
3	M8 x 20 Hex Bolt	M8 x 20 Hex Bolt	4
4	M8 x 20 Cup Screw	M8 x 20 Cup Screw	8
5	M8 Flat washer	M8 Flat washer	12
6	M8 SS Nyloc Nuts	M8 SS Nyloc Nuts	12

### **Tools required to fit Load Bar Table Bracket kit:**

<b><u>TOOL</u></b>	<b><u>PURPOSE</u></b>
13mm spanner	Spanner to tighten various bolts
13mm socket	Fastening various bolts
Ratchet	Fastening various bolts
Allen key	Tightening bolts

### **Consumables required:**

<b><u>ITEM</u></b>	<b><u>PURPOSE</u></b>
Loctite or similar adhesive	Apply to Counter sunk bolts in table mounting lock

**Part Identification:**

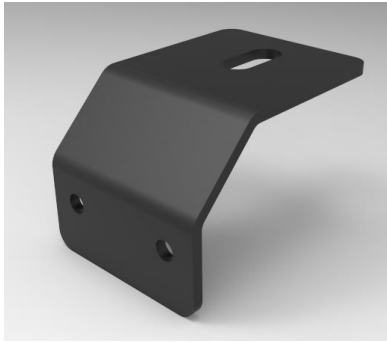

TABLE MOUNT BRACKET

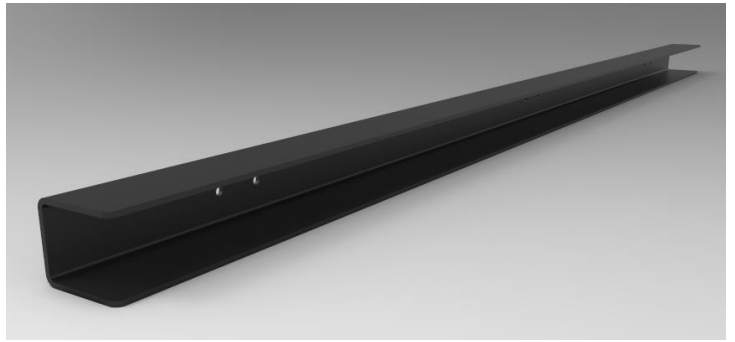
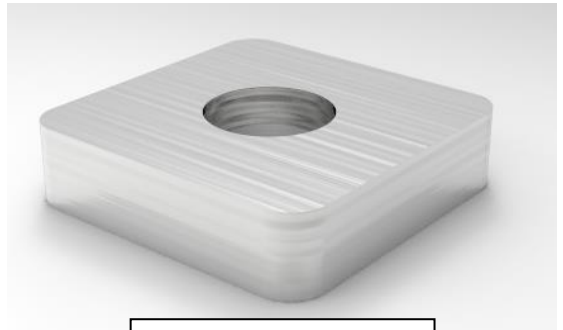

TABLE MOUNTING BRACKET



Lock Mount Bracket



CARGO RAIL NUT

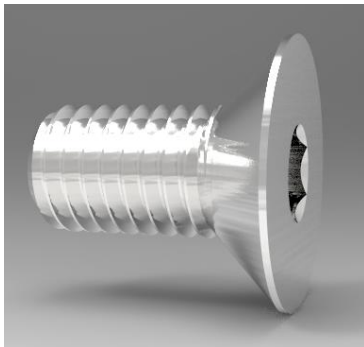

M6x10 COUNTER SUNK  
SCREW



M8 ANTI-LUCE LOCK

**PLEASE NOTE:**

- To use the Load Bar Table Slide on your Alu-Cab Camper, Gen 3 Tent or Canopy, you will need a set of Alu-Cab load bars with Roof Rack feet
- To use the Roof Rack Tray on your Alu-Cab Camper, Gen 3 Tent or Canopy with the Load Bar Table Slide, you will need a set of Alu-Cab load bars with Roof Rack feet.

**Step 1: Fasten the 4 x roof rack feet to cargo rails**

Assemble the roof rack feet to the cargo rail as shown below. The nyloc nuts on the bottom of the load bar feet should not be tightened completely to allow the load bar to slide in the cargo rail. This will make it easier to manoeuvre while fitting the roof rack tray.

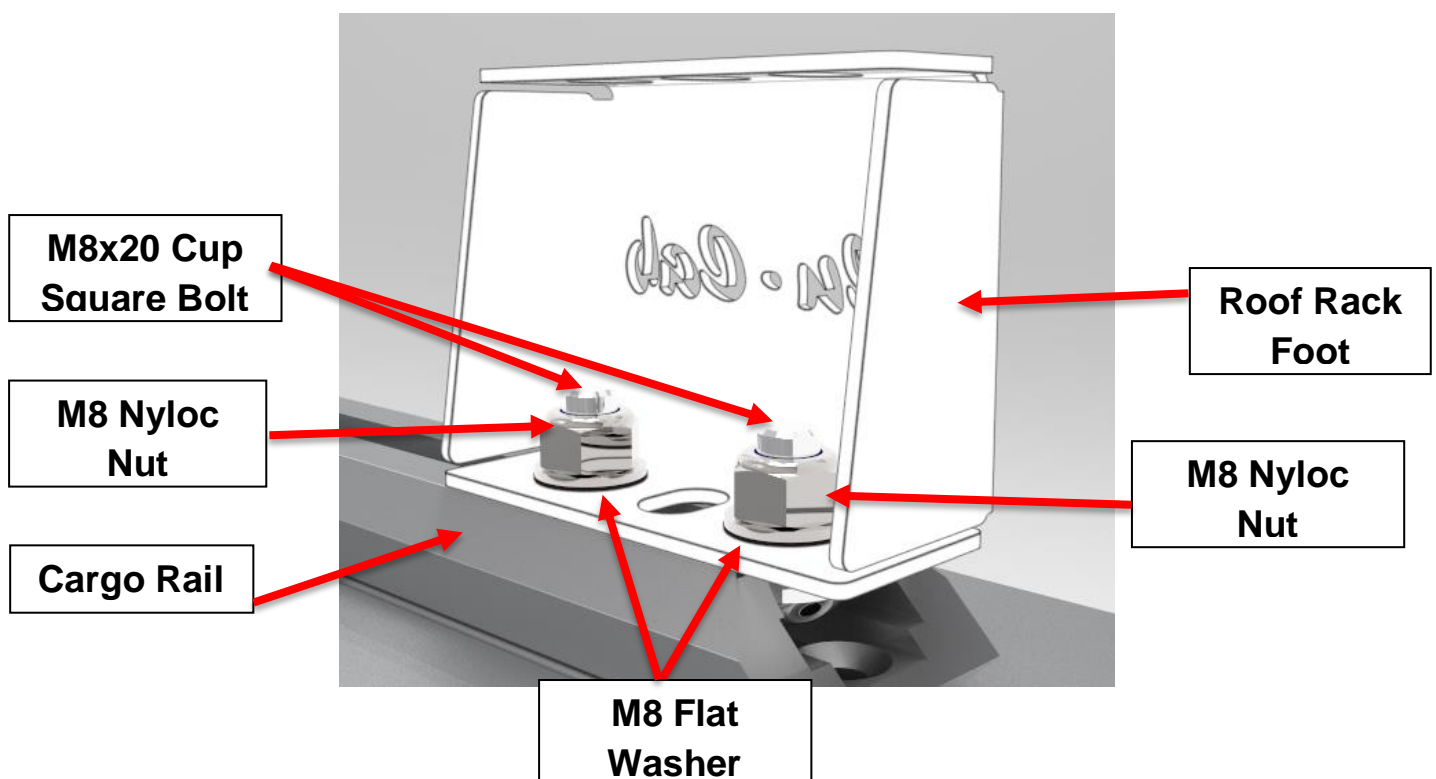

**Step 2: Insert bracket bolts into load bars**

**(skip this step if you are not installing a load bar table slide)**

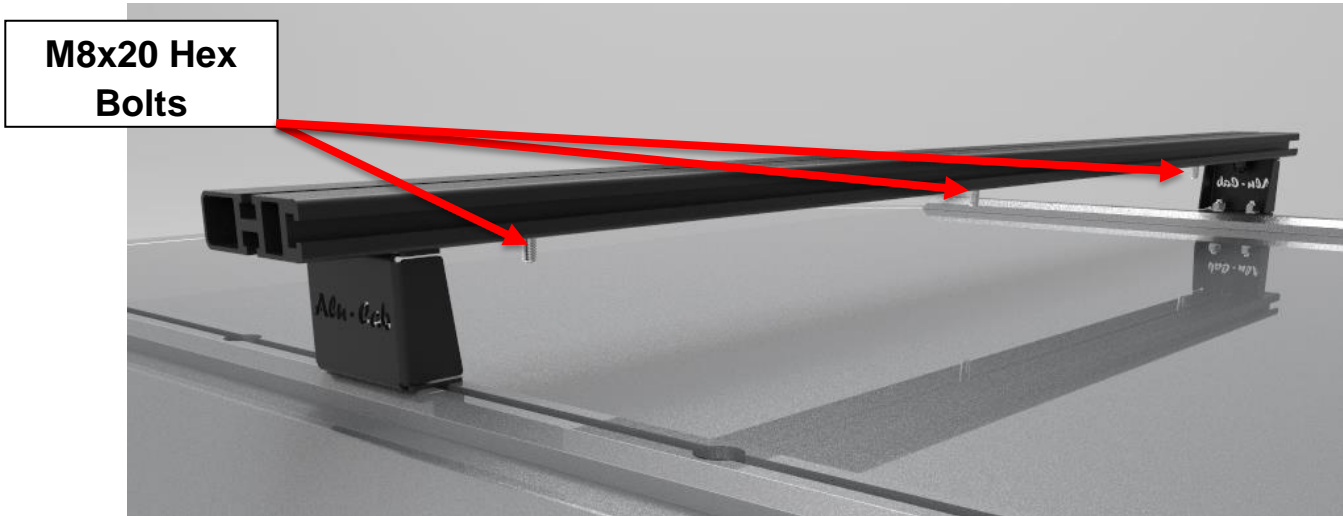

Remove the plastic end caps of the load bars and slide 3 x M8x20 Hex bolts into the bottom slot of each load bar. This will be used to bolt the load bar table slide to the load bars.

**Step 3: Mount and fasten load bars to Roof rack feet loosely**

Mount and fasten Load bars loosely to roof rack feet as shown below, mounting it loosely will make it easier to move while assembling:

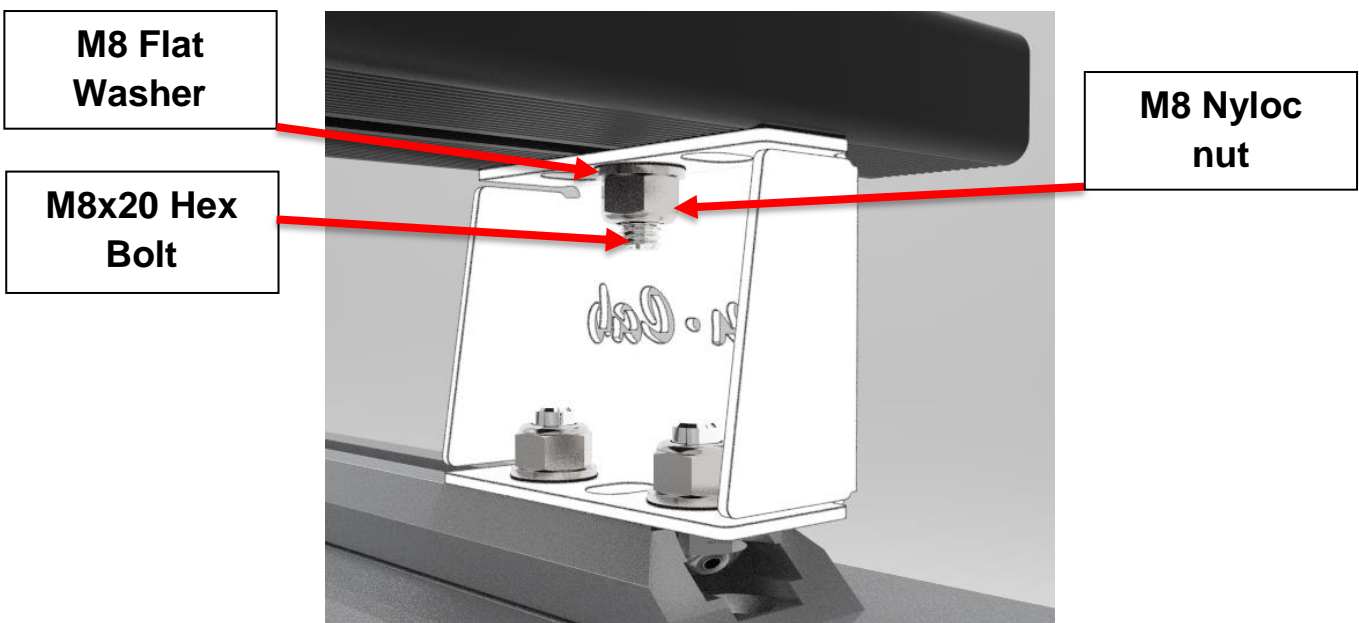

**Step 4: Mount Roof Rack Tray (SKIP THIS STEP IF NO ROOF TRAY WILL BE INSTALLED)**

Slide 7 x M8x20 Hex Bolts into each load bar. Mount the roof rack tray using the 14 x M8x20 Hex Bolts, 14 x M8x17 flat washers and M8 Nyloc nuts as shown below. Ensure that the load

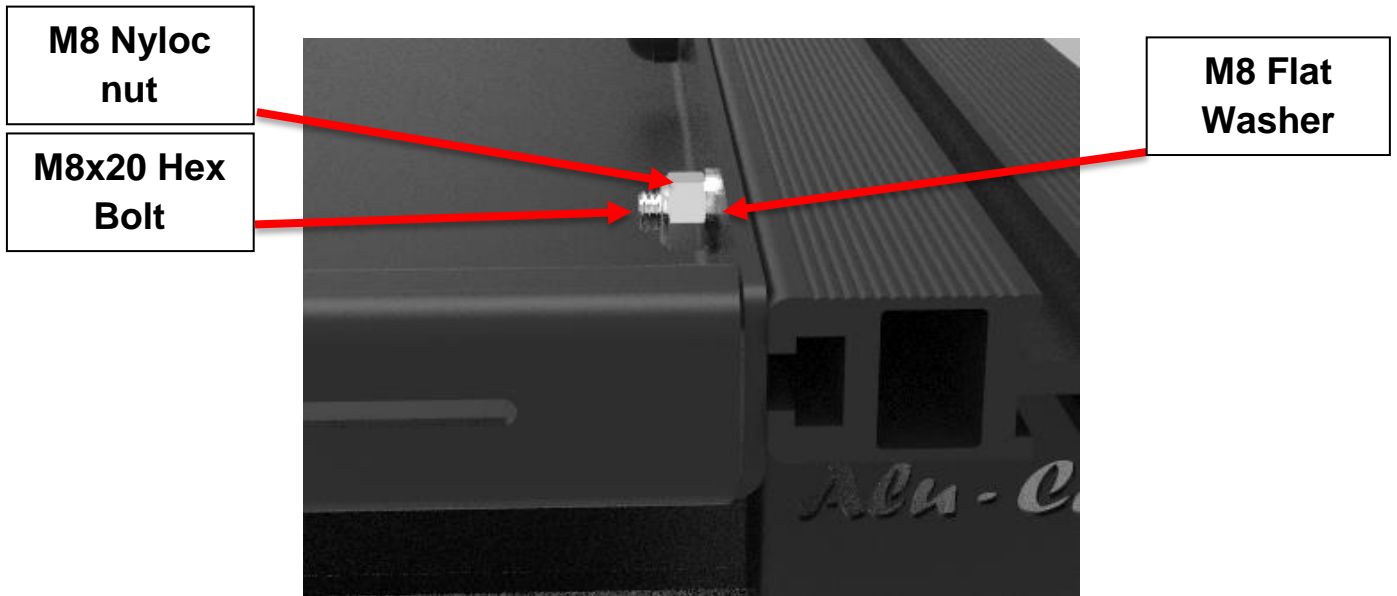

**Step 5: Fasten load bar table slide brackets into load bars**

Using the 3 x M8x20 Hex bolts inserted into each load bar in step 2, fasten the load bar table slide brackets to the load bars as show below:

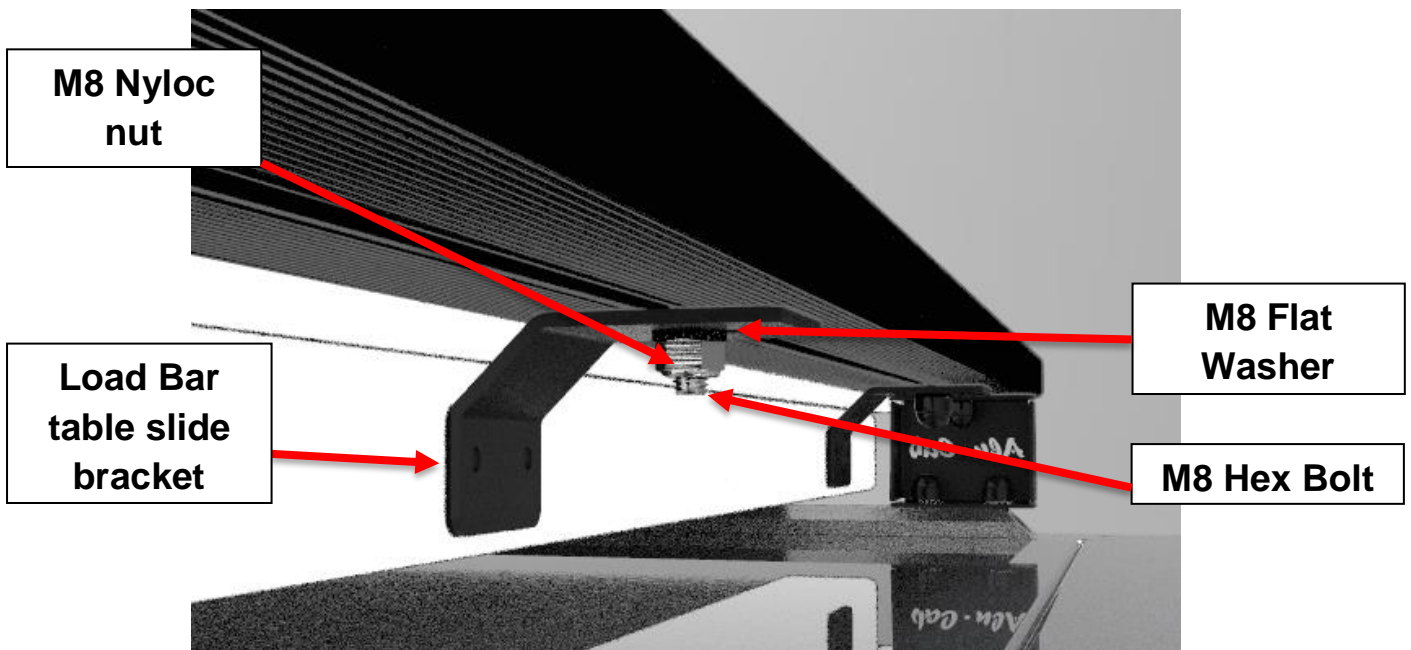

**Step 6: Fasten Table Mounting lock bracket into cargo rail**

Assemble the table mounting lock into the cargo rail as shown below.  
***Apply Loctite or Similar fastener adhesive to the thread of the M6x10 Counter sunk bolt to prevent them from coming loose.***

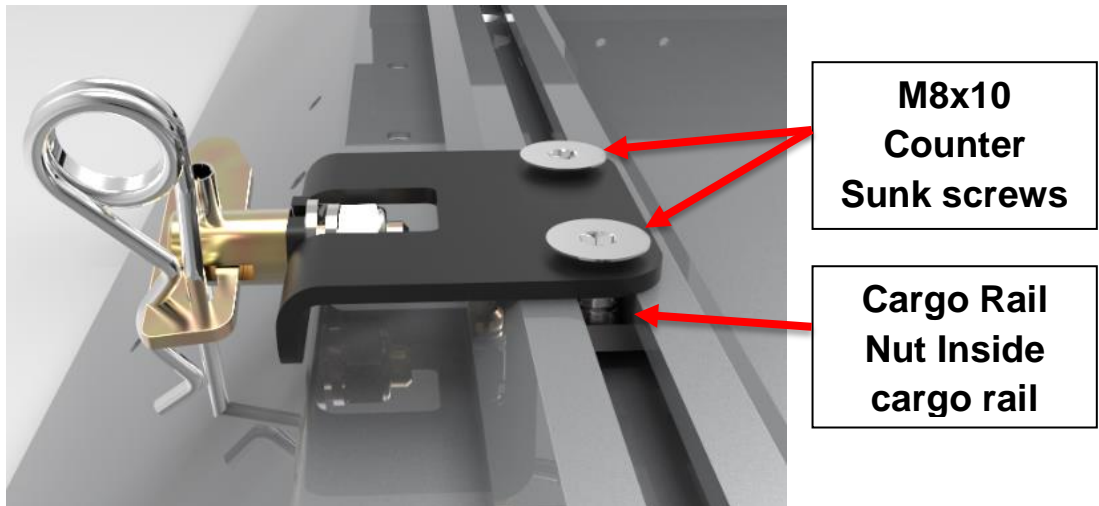

**Step 7: RE-INSERT PLASTIC LOAD BAR END CAPS INTO THE END OF THE LOAD BARS**

**Step 8: PLACE M8 PLASTIC NUT CAPS ON ALL M8 NYLOCK NUTS**

The install is now complete.

